

POINTAX 6000M

3-348-822-03
1 / 8.97



Contents

	Page
1 Description	3
2 Technical Data	3
2.1 RS 485 Bus Connection	3
3 Data Formats	3
4 Data Transmission	4
4.1 General	4
4.2 Message Characters (UART Characters or Frames)	4
4.3 Allowable Addresses	4
4.3.1 Broadcast Address	4
4.4 Message Formats, Frame Specifications	4
4.4.1 SD1 Messages	4
4.4.2 SD2 Messages	5
4.4.3 SD3 Messages	5
4.5 Transmission Performance	5
5 Parameters	6
5.1 Addressable Parameters	6
5.2 Assignment of the Instrument Functions Group to Parameter field Addresses	6
5.3 Parameter Addresses	6
5.3.1 Systems Parameter 10H	6
5.3.2 Channel Parameters 11 ... 16H	8
5.3.3 Text Lines, 17H	10
5.3.4 Print Intervals, 18H	10
5.3.5 Text Printing Synchronization Times, 19H	10
5.3.6 Print Colors, 1AH	10
5.3.7 Assignment, DI 1BH	11
5.3.8 Date and Time, 1CH	11
5.3.9 Calibration Data, 1DH	11
5.3.10 Channel Measurement Values and Device Status, 1EH	11
5.3.11 Entering Measurement Values to the Recorder, 1FH	13
5.3.12 Read Balancing Data, 20H	13
5.3.13 Write Device Status, 21H	14
6 Text Block Generation	14
6.1 Transmit Print Lines to the Recorder (with parameter field address F1H)	14
6.2 Printer Status Query	15
6.3 Send Display Lines to Recorder, F2H (for display instruments)	15
6.4 Communications Error Registers, FFH	15
7 WIZCON Link at the Recorder	16
7.1 8 Value Query (with SD3 message and function code 04H)	16
7.2 Changing 2 Values (with SD3 message and function code 07H)	16
7.3 Numbers Format	16
7.4 Parameter Addresses for Function Codes 04H and 07H	16
7.5 Binary Information Queries (with SD3 message and function code 05H)	17
7.6 Parameter Addresses for Function Code 05H	17
8 Character Table	18

1 Description

The RS 485 interface is used for communication with the point recorder.

Setting of parameters is accomplished with the control panel at the recorder, or via the interface with the help of a PC and PARATOOL P6000M parameter assignment software.

The data transmission protocol conforms to DIN 19 245 Part 1 (Profibus protocol). Inclusion of settings has been limited to a subset only. For example, settings for multi-master operation (token passing procedures) have not been included, because the point recorder always functions as a passive user.

2 Technical Data

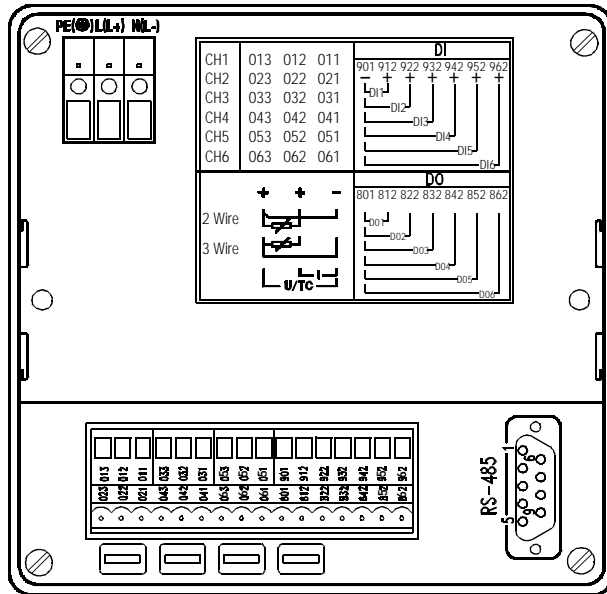

Figure 1 POINTAX 6000M Rear Panel

2.1 RS 485 Bus Connection

Bus Structure	Line, no branches, spur lines to users < 0.3 m
Medium	Shielded, twisted 2 wire line, Wave impedance 100 ... 130 Ω, at f > 100 kHz Cable capacity < 60 pF/m Cross section min. 0.22 mm ²
Line Length	max. 1200 m
Number of Users	32 (active and passive)
Transmission Speed	600, 1,200, 2,400, 4,800 9,600 and 19,200 baud.
Transmission Type	symmetric
Driver Output	Open circuit ± 15 V, with load ≥ ± 5 V Load resistance ≥ 60 Ω
Receiver	Sensitivity 200 mV Input resistance 12 kΩ
Grounding	Shield to be grounded at both ends for the discharge of high frequency interference.
Potential Equalization	The potential difference between the data reference potential (GND) of all bus users may not exceed ± 7 V

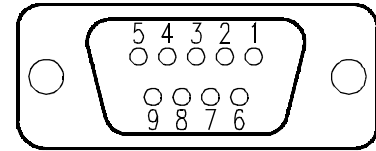

Figure 2 RS 485 Interface Connector Pin Assignment (9 pole Sub-D port)

- 1 = Shield
- 3 = RXD (+)
- 4 = I/O converter (+)
- 5 = GND (reference potential)
- 6 = + 5 V
- 8 = RXD (-)
- 9 = I/O converter (-)

The voltage, +5 V, at pin 6 is only required if the POINTAX 6000M is used as a bus terminal device.

The shield is attached to a knife-type connector on the recorder housing.

Open-circuit potential of the bus is regulated with the help of resistors Ru, Rt and Rd.

- Ru = 390 Ω
- Rt = 150 Ω
- Rd = 390 Ω

Connections are made as shown in figure 3.

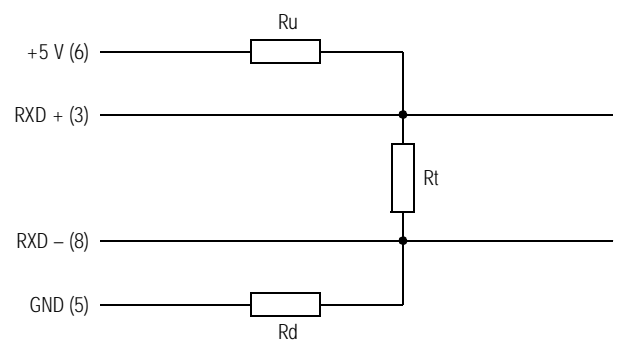

Figure 3 Bus Terminal Wiring

Resistors Ru, Rt and Rd are installed into the 9 pole bus plug, so that the recorder can be disconnected from the bus without affecting bus termination.

3 Data Formats

Data to be transmitted are formatted into 4 different data types.

1. Byte type value range 0 ... 255
2. Char type value range -128 ... +127
3. Word type value range 0...65535
4. Float type value range ± 1.175494E-38 ... ± 3.402823E+38

Byte Type

The byte type format is used for the selection of parameters from the tables (see chapter 5.3).

Char Type

The char type format is used for the transmission of ASCII characters. The character set which is accepted by the recorder is shown in chapter 8.

Hex codes are to be used.

Word Type

The word type format consists of 2 bytes and is used for the transmission of integers without sign (whole number values). During transmission, the high byte is transmitted prior to the low byte.

Example: A value of 820 is to be transmitted.
820 dec. = 03 34H

Float Type

The float type format consists of 4 bytes (IEEE-754 format) and is used for the transmission of floating point values. The recorder accepts numeric values ranging from -1000 ... +9999.

Example:
A value of -12.5 is to be transmitted.
-12.5 dec. = C1 48 00 00H

Determination of the Hexadecimal Number
The basic form of the floating point number is:

$$(\text{sign}) \cdot 2^{\text{EXP}-127} \cdot (\text{remainder})$$

Binary Representation of the Number -12.5

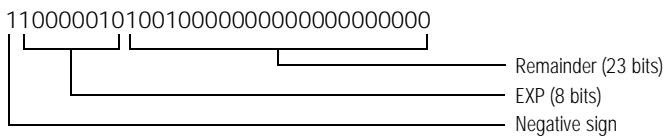

1. Determination of the Sign
The bit is set for the negative sign.
2. Determination of the Exponent
The highest exponent is determined.

$$\text{EXP} = \text{INT} [\lg |\text{Number}| / \lg 2] + 127$$

Example:
 $\text{INT} [\lg 12.5 / \lg 2] + 127 = 130\text{D} = 82\text{H} = 10000010$

3. Determination of the Remainder

$$\text{Remainder} = |\text{Number}| / 2^{\text{EXP}-127}$$

Example:
 $12.5 / 2^3 = 1.5625$

Conversion to Binary Code:

$$\text{Valency} \quad 2^0 + 2^{-1} + 2^{-2} + 2^{-3} + 2^{-4} + \dots 2^{-23}$$

Example: (1) 1 0 0 1

The value 2^0 is always 1, and is thus not transmitted.

4 Data Transmission

4.1 General

A group of message characters are combined for data transmission. The messages assume the "handshake function", i.e. each message from the computer to the recorder must first be acknowledged, before the next message can be sent.

Note

The interface address and the baud rate parameters must be set at the recorder prior to data transmission.

4.2 Message Characters (UART Characters or Frames)

Each frame (character) has 11 bits:

- 1 start bit (ST) with low level signal
- 8 information bits with low or high level signal
- 1 parity bit (P) with low or high level signal
- 1 stop bit (SP) with high level signal

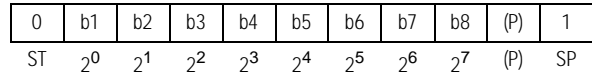

Figure 4 Bits Included in one Frame

4.3 Allowable Addresses

The recorder only answers queries, which use destination addresses which have been set up in the instrument. Values from 0 ... 126 (= 7EH) are allowable. Assignments can be made as desired. Each address may, however, only be assigned once. The recorder does not respond to incorrect addresses (check sum, incorrect address or other receiving errors). In addition, no acknowledgement of incorrect messages occurs. Some data areas are flagged as read only memory. Attempts to write to these data fields are ignored by the recorder.

4.3.1 Broadcast Address

Messages to the broadcast address (132D) are processed by all recorders, although no response is made to broadcast messages.

4.4 Message Formats, Frame Specifications

The recorder accepts the following types of messages:

4.4.1 SD1 Messages

Messages with a fixed information field length without data array:

SD1/ DA/SA/FC /FCS/ED
|<--- L--->|

This is used for sending a query to the recorder and as an acknowledgement from the recorder.

The following applies in this case:

SD1 = 10H	Start delimiter, code: 10H
DA	Destination address
SA	Source address
FC	Frame control
FCS	Check byte (frame check sequence) Sum of the hex. values of the „L“ frames without transmission at FFH
ED	End delimiter, code: 16H
L	Number of bytes in FCS = 3

In response to a query where FC = 01H (identification query) the recorder also answers in the SD1 format. If no self-test error occurs in the instrument, the response is FC = 10H, or otherwise FC = 11H.

Recorder identification recognition is performed with function code 4EH in accordance with an internal standard.

In response to a query where FC = 4EH the recorder responds with a type SD2 message (see chapter 4.4.2).

5 Parameters

5.1 Addressable Parameters

The following parameters can be read or changed with the messages described in chapters 4.4.2 and 4.4.3. The entry of a parameter field address, a parameter address (offset) and the parameter value code is required to this end.

Parameter field addresses can be found in chapter 5.2.

Parameter addresses can be found in chapter 5.3.

The following entries are thus required for the first advance:

Parameter field address: 10H
 Parameter address (offset): 0000H
 Advance code for 20 mm/hr.: 04H

5.2 Assignment of the Instrument Functions Group to Parameter field Addresses

Instrument Functions Group	Parameter Field Address
Systems Parameter Settings	10H
Channel 1 Parameter Settings	11H
Channel 2 Parameter Settings	12H
Channel 3 Parameter Settings	13H
Channel 4 Parameter Settings	14H
Channel 5 Parameter Settings	15H
Channel 6 Parameter Settings	16H
Text Lines	17H
Print Intervals	18H
Print Synchronization Time	19H
Print Colors	1AH
DI Assignment	1BH
Date and Time	1CH
Calibration Data	1DH
Measurement Value and Instrument Status	1EH
Transmit Measurement Values to Recorder	1FH
Read Balancing Data (block transfer)	20H
Write Instrument Status	21H
Transmit Print Line	F1H
Transmit Display Line to Recorder	F2H
Communications Error Register	FFH

The above mentioned addresses are inserted into the corresponding message field. The recorder determines the range of data to be transmitted from the address.

Type SD2 and SD3 messages are used for transmission. FC 15H must always be used for the reading of data arrays. FC 16H is used for writing data arrays. If invalid parameter values are used in the writing of a message, the recorder responds with a negative acknowledgement (SD1, FC = 11H).

5.3 Parameter Addresses

5.3.1 Systems Parameter 10H

Parameter Address (offset)	Data Type	Function and Code
0000H	Byte	Advance 1 00H = off 01H = 2.5 mm/hr. 02H = 5 mm/hr. 03H = 10 mm/hr. 04H = 20 mm/hr. 05H = 30 mm/hr. 06H = 40 mm/hr. 07H = 60 mm/hr. 08H = 120 mm/hr. 09H = 240 mm/hr. 0AH = 300 mm/hr. 0BH = 600 mm/hr. 0CH = 1200 mm/hr.
0001H	Byte	Advance 2 same as advance1
0002H	Byte	unoccupied
0003H	Byte	Operating Mode 00H = operating mode A 01H = operating mode B 02H = operating mode C 03H = operating mode D 04H = operating mode E
0004H	Word	Cycle Time, Measurement Value Printing 0003H = 3 s . = . . = . 0168H = 360 s
0006H	Byte	Delay for External Controls 00H ... 1EH = 0 ... 30 s
0007H	Byte	unoccupied
0008H	Byte	Number of Event Marks 00H = none 01H = 1 . = . 0AH = 10
0009H	Byte	Date-Time Format 00H = European 01H = American
000AH	Byte	Simulation Type 00H = off 01H = slope 02H = sine 03H = steps (10%)
000BH	Word	Simulation Duration 0014H 07DOH (20 ... 2000 sec.)
000DH	Time	Time with External Clock Synchronization hour (high byte) 00 ... 23 = 00H ... 17H minute (low byte) 00 ... 59 = 00H ... 3BH
000FH	Byte	Baud Rate 00H = 600 01H = 1200 02H = 2400 03H = 4800 04H = 9600 05H = 19200
0010H	Byte	Instrument Address 0 ... 126 = 00H ... 7EH
0011H	Byte	Language Selection 00H = direct-read device 01H = German 02H = English 03H = French
0012H	Byte	Alarm Acknowledgement 00H = off 01H = manual 02H = automatic
0013H	Byte	Cumulative Alarm Output 00H = off 01H = DO 1 . = . . = . 14H = DO 20

Systems Parameter 10H Continued

Parameter Address (offset)	Data Type	Function and Code	
0014H	Byte	Cumulative Alarm Output	00H = off 01H = DO 1 . = . . = . 14H = DO 20
0015H	Byte	LCD Background Illumination	00H = off 01H = on
0016H	Byte	Channel and Scale Display	00H = off 01H = channel display 02H = display channel + scale
0017H	Byte	unoccupied	
0018H	Word	Space Between Scaling Lines	0028H ... 01F4H (40 ... 500 mm)
001AH	Byte	Print Advance Selection	00H = no 01H = yes
001BH	Byte	Print Channel Number at Curve	00H = no 01H = yes
001CH	Byte	Limit Value Text Line with Limit Value	00H = no 01H = yes
001DH	Byte	reserved	
001EH	Byte	I/O Converter Installed	00H = no 01H = yes
001FH	Byte	Relay Status	00H = closed-circuit 01H = operating current
0020H	Byte	reserved	
0021H	Byte	reserved	
0022H	Word	Password	0000H ... 270EH = 0 ... 9998
0024H	Word	Counter Increment	0000H ... 03E8H (0 ... 1000)
0026H	Byte	Counting Direction	00H = add 01H = subtract
0027H	Byte	Assigned Text Line	00H = counter off 01H = text line 1 . = . . = . 0AH = text line 10
0028H	Word	Set Counter Upper 4 Digits	0000H ... 270FH (0 ... 9999)
002AH	Word	Set Counter Lower 4 Digits	0000H ... 270FH (0 ... 9999)
002CH	Word	Generation of Message Block 1 The coding of lines combined into one message block is generated by summing the individual codes. Message block 1 is coupled to DI 1.	00H = off 01H = value CH 1 02H = value CH 2 04H = value CH 3 08H = value CH 4 10H = value CH 5 20H = value CH 6 40 H = Txt 1 80 H = Txt 2 100H = Txt 3 200H = Txt 4 400H = Txt 5 800H = Txt 6 1000H = Txt 7 2000H = Txt 8 4000H = Txt 9 8000H = Txt10
002EH	Word	Generation of Message Block 2 Message block 2 is coupled to DI 2.	same as message block 1
0030H	Word	Generation of Message Block 3 Message block 3 is coupled to DI 3.	same as message block 1

Systems Parameter 10H Continued

Parameter Address (offset)	Data Type	Function and Code	
0030H	Word	Generation of Message Block 4 Message block 4 is coupled to DI 4.	same as message block 1
0034H	Byte	Standby Operating Mode	00H = inactive 01H = on via DI; off via LV 02H = on via DI; off via MF key 03H = on via power on; off via LV 04H = on via power on; off via MF key
0035H	Byte	Standby Delay Time	00H ... C8H (0 ... 200 min.)
0036H	Word	Standby Limit Value Code	0000H = inactive 0001H = CH1; LV1 0002H = CH1; LV2 0004H = CH2; LV1 0008H = CH2; LV2 0010H = CH3; LV1 0020H = CH3; LV2 0040H = CH4; LV1 0080H = CH4; LV2 0100H = CH5; LV1 0200H = CH5; LV2 0400H = CH6; LV1 0800H = CH6; LV2
0038H	Word	reserved	
003AH	Byte	16 Digit LCD Brightness	00H = off 01H = 1 st level 02H = 2 nd level 03H = 3 rd level 04H = 4 th level
003BH	Byte	Enable Virtual Channels 7 ... 12	00H = off 01H = on
003CH	Byte	Display Bar Graphs at 16 Digit LCD	00H = off 01H = on

5.3.2 Channel Parameters 11 ... 16H

Parameter Address (offset)	Data Type	Function and Code
0000H	Byte	Input Type 00H = off 01H = 0 ... 20 mA 02H = 4 ... 20 mA 03H = ± 2.5 mA 04H = ± 5.0 mA 05H = ± 20 mA 06H = 0 ... 25 mV 07H = ± 25 mV 08H = 0 ... 100 mV 09H = ± 100 mV 0AH = 0 ... 500 mV 0BH = 0 ... 2.5 V 0CH = ± 2.5 V 0DH = 0 ... 5 V 0EH = ± 5 V 0FH = ± 10 V 10H = ± 20 V 11H = PT100 I (-50 ... +150°C) 12H = PT100 II (-50 ... +500°C) 13H = PT100 III (-200... +850°C) 14H = TC B 15H = TC E 16H = TC J 17H = TC K 18H = TC L 19H = TC N 1AH = TC R 1BH = TC S 1CH = TC T 1DH = TC U 1EH = RS 485
0001H	Byte	Temperature Units of Measure 00H = °C 01H = °F
0002H	Byte	Physical Units of Measure 00H = undefined 01H = mA 02H = A 03H = mV 04H = V 05H = mbar 06H = bar 07H = Pa 08H = kPa 09H = °C 0AH = °F 0BH = K 0CH = r.p.s. 0DH = r.p.m. 0EH = % 0FH = ‰ 10H = kW 11H = MW 12H = r.p.m. 13H = m ³ /hr.
0003H	Byte	Display Format 00H = linear 01H = linear with 2 slopes 02H = linear with 3 slopes 03H = logarithmic
0004H	Byte	Enable Channel Display 00H = off 01H = on
0005H	Float	Meas. Range Lower Limit -999 ... +9999
0009H	Float	Meas. Range Upper Limit -999 ... +9999
000DH	Float	Display Range Lower Limit -999 ... +9999 1.00E-9 ... 9.99E+9 for logarithmic display range

Channel Parameters 11 ... 16H Continued

Parameter Address (offset)	Data Type	Function and Code
0011H	Float	Display Range Upper Limit -999 ... +9999 1.00E-9 ... 9.99E+9 for log. display range
0015H	Float	1 st node for non-linear display range Display Range Value -999 ... +9999
0019H	Float	1 st node for non-linear display range Display Range Value -999 ... +9999
001DH	Float	2 nd node for non-linear display range Display Range Value -999 ... +9999
0021H	Float	2 nd node for non-linear display range Display Range Value -999 ... +9999
0025H	Float	Results Range Lower Limit -999 ... +9999
0029H	Float	Results Range Upper Limit -999 ... +9999
002D	Byte	Recording Range Lower Limit 0 ... 90
002EH	Byte	Recording Range Upper Limit 10 ... 100
002FH	Integer	Measurement Value Correction Offset -1000 ... +1000
0031H	Word	reserved
0033H	Byte	Filtering Time 00H ... 3CH =0 ... 60 s
0034H	Byte	Recording Direction 00H = no 01H = yes
0035H	Byte	Binary Root Extraction 00H = off 01H = on
0036H	Byte	Reference Point Temperature 00H = 0 °C 01H = 20 °C 02H = 50 °C 03H = 60 °C 04H = 70 °C 05H = internal 06H = CH 6
0037H	Byte	Number of places after the decimal for measurement value display 00H = floating point 01H = 0 02H = 1 03H = 2 04H = 3
0038H	Byte	PT 100 Connection 00H = 2 wire 01H = 3 wire
0039H	Float	Cable Resistance 0 ... 40 Ω
003DH	Byte	Ruptured Sensor Performance 00H = meas. signal 0% 01H = meas. sig. 100%
003EH	Byte	Enable Rupture Monitoring 00H = off 01H = on
003FH	Byte	Fixed Line Resistance for Pt 100 2-Wire Circuit 00H = pre-select resistance 01H = measured resistance
0040H	Byte	reserved

Parameter Address (offset)	Data Type	Function and Code	
0041H	Byte	Scale LED Assignment	00H = none 01H = LED 1 top 02H = LED 2 03H = LED 3 04H = LED 4 05H = LED 5 06H = LED 6 bottom
0042H	Byte	Arithmetic Function	00H = off 01H = addition 02H = subtraction
0043H	Byte	Interconnective Channel #1	00H = Channel 1 02H = Channel 2 03H = Channel 3 04H = Channel 4 05H = Channel 5 06H = Channel 6
0044H	Byte	Interconnective Channel #2	00H = Channel 1 02H = Channel 2 03H = Channel 3 04H = Channel 4 05H = Channel 5 06H = Channel 6
0045H	Byte	reserved	
0046H	Float	Limit Value #1	-999 ... 9999 1.00E-9 ... 9.99E+9 for log. display range
004AH	Float	Limit Value #2	-999 ... 9999 1,00E-9 ... 9,99E+9 for log. display range
004EH	Byte	Effective Direction Limit Value #1	00H = min. 01H = max.
004FH	Byte	Effective Direction Limit Value #2	00H = min. 01H = max.
0050H	Byte	Relay Output for Limit Value #1	00H = off 01H = DO 1 . = . . = . 14H = DO 20
0051H	Byte	Relay Output for Limit Value #2	00H = off 01H = DO 1 . = . . = . 14H = DO 20
0052H	Byte	Text Line for Limit Value #1	00H = none 01H = text line 1 . = . . = . 0AH = text line 10
0053H	Byte	Text Line for Limit Value #2	same as limit value #1
0054H	Word	reserved	
0056H	Byte	Balancing: Operating Mode	00H = off 01H = mean value 02H = sum value 03H = sum + limit value
0057H	Byte	Balancing: External Controls	00H = off 01H = DI 1 . = . 0EH = DI 14
0058H	Byte	Balancing Interval	00H = 15 min. 01H = 30 min. 02H = 1 hr. 03H = 2 hr. 04H = 6 hr. 05H = 8 hr. 06H = 12 hr. 07H = 1 day 08H = 7 days 09H = 1 month

Parameter Address (offset)	Data Type	Function and Code	
0059H	Word	Synchronization Time = Start Time Interval	hour (high byte) 00H ... 17H = 0 ... 23 minute (low byte) 00H ... 3BH = 0 ... 59
005BH	Byte	Synchronization Day	00H = ignore 01H = 1 st day . = . 1FH = 31 st day
005CH	Byte	Comment Line	00H = no text line 01H = text line 1 . = . 0AH = text line 10
005DH	Float	Limit Value Forwarding	1 ... 7.500E6 3F 80 00 00H ... 4A E4 E1 COH (floating format)
0061H	Byte	Relay Output for Limit Value Balancing	00H = off 01H = DO 1 . = . 14H = DO 20
0062H	Byte	Print Format for Balancing Table	01H = channel line 02H = interval duration 04H = min. value 08H = max. value 10H = mean value 20H = sum value
0063H	Byte	Print Sum for Exceeded Limit Values	00H = no 01H = yes
0064H	Byte	Record Sum Instead of Measurement Value	00H = no 01H = yes
0067H	Char	Freely Selectable Unit of Measure (max. 7 Characters)	00H = 1st character 01H = 2nd character . = . . = . 06H = 7th character
006EH	Char	Scaling Text Line (max. 32 characters)	00H = 1st character 01H = 2nd character . = . . = . 1FH = 32nd character
00A4H	Byte	Scaling Line Format	00H = no print 01H = 2 graduations 02H = 3 graduations 03H = 5 graduations 04H = freely selectable
00A5H	Byte	Enable User Linearization	00H = off 01H = on
00A6H	Word	Node x1	0000H ... 03E8H (0 ... 1000)
00A8H	Word	Node y1	0000H ... 03E8H (0 ... 1000)
00AAH	Word	Node x2	0000H ... 03E8H (0 ... 1000)
00ACH	Word	Node y2	0000H ... 03E8H (0 ... 1000)
...
...
...
00DEH	Word	Node x15	0000H ... 03E8H (0 ... 1000)
00EOH	Word	Node y15	0000H ... 03E8H (0 ... 1000)
00E2H	Word	Node x16	0000H ... 03E8H (0 ... 1000)
00E4H	Word	Node y16	0000H ... 03E8H (0 ... 1000)

5.3.3 Text Lines, 17H

Parameter Address (offset)	Data Type	Function and Code	
0000H	Char	Text Line #1 max. 32 characters	value range: 01H ... 07H 20H ... 7FH DEH ... F8H code: 00H = 1 st character 01H = 2 nd character . = . . = . 1FH = 32 nd character
0020H	Char	Text Line #2	same as line 1
0040H	Char	Text Line #3	same as line 1
0060H	Char	Text Line #4	same as line 1
0080H	Char	Text Line #5	same as line 1
00A0H	Char	Text Line #6	same as line 1
00C0H	Char	Text Line #7	same as line 1
00E0H	Char	Text Line #8	same as line 1
0100H	Char	Text Line #9	same as line 1
0120H	Char	Text Line #10	same as line 1

The character 20H must be entered for unused character positions. All characters must lie within a range of 01 ... 07; 20H ... 7FH and DEH ... F8H. If invalid characters are discovered by the recorder they are replaced with 20H, and the negative acknowledgement is transmitted in response.

5.3.4 Print Intervals, 18H

Parameter Address (offset)	Data Type	Function and Code	
0000H	Byte	Print Interval for Text Line #1	00H = off 01H = 15 min. 02H = 30 min. 03H = 1 hr. 04H = 2 hr. 05H = 3 hr. 06H = 8 hr. 07H = 12 hr. 08H = 24 hr.
0001H	Byte	Print Interval for Text Line #2	same as text line 1
0002H	Byte	Print Interval for Text Line #3	same as text line 1
0003H	Byte	Print Interval for Text Line #4	same as text line 1
0004H	Byte	Print Interval for Text Line #5	same as text line 1
0005H	Byte	Print Interval for Text Line #6	same as text line 1
0006H	Byte	Print Interval for Text Line #7	same as text line 1
0007H	Byte	Print Interval for Text Line #8	same as text line 1
0008H	Byte	Print Interval for Text Line #9	same as text line 1
0009H	Byte	Print Interval for Text Line #10	same as text line 1
000AH	Byte	Print Interval for Measurement Value Table	same as text line 1
000BH	Byte	Print Interval for Date and Time	same as text line 1
000CH	Byte	Print Interval for Time	same as text line 1

5.3.5 Text Printing Synchronization Times, 19H

Parameter Address (offset)	Data Type	Function and Code	
0000H	Word	Synchronization Time for Cyclical Printing of Text Line #1	hour (high byte) 00H ... 17H = 0 ... 23 minute (low byte) 00H ... 3BH = 0 ... 59
0002H	Word	Synchronization Time for Cyclical Printing of Text Line #2	same as text line 1
0004H	Word	Synchronization Time for Cyclical Printing of Text Line #3	same as text line 1
0006H	Word	Synchronization Time for Cyclical Printing of Text Line #4	same as text line 1
0008H	Word	Synchronization Time for Cyclical Printing of Text Line #5	same as text line 1
000AH	Word	Synchronization Time for Cyclical Printing of Text Line #6	same as text line 1
000CH	Word	Synchronization Time for Cyclical Printing of Text Line #7	same as text line 1
000EH	Word	Synchronization Time for Cyclical Printing of Text Line #8	same as text line 1
0010H	Word	Synchronization Time for Cyclical Printing of Text Line #9	same as text line 1
0012H	Word	Synchronization Time for Cyclical Printing of Text Line #10	same as text line 1
0014H	Word	Synchronization Time for Cyclical Printing of Measurement Value Table	same as text line 1
0016H	Word	Synchronization Time for Cyclical Printing of Date and Time	same as text line 1
0012H	Word	Synchronization Time for Cyclical Printing of Time	same as text line 1

The recorder also processes synchronization times in the 24 hour format for the US date format.

5.3.6 Print Colors, 1AH

Parameter Address (offset)	Data Type	Function and Code	
0000H	Byte	Print Color for Measurement Channel #1	00H = none 01H = violet 02H = red 03H = black 04H = green 05H = blue 06H = brown
0001H	Byte	Print Color for Measurement Channel #2	same as measurement channel #1
0002H	Byte	Print Color for Measurement Channel #3	same as measurement channel #1
0003H	Byte	Print Color for Measurement Channel #4	same as measurement channel #1
0004H	Byte	Print Color for Measurement Channel #5	same as measurement channel #1
0005H	Byte	Print Color for Measurement Channel #6	same as measurement channel #1

Parameter Address (offset)	Data Type	Function and Code	
0006H	Byte	Print Color for Text Line #1	same as measurement channel #1
0007H	Byte	Print Color for Text Line #2	same as measurement channel #1
0008H	Byte	Print Color for Text Line #3	same as measurement channel #1
0009H	Byte	Print Color for Text Line #4	same as measurement channel #1
000AH	Byte	Print Color for Text Line #5	same as measurement channel #1
000BH	Byte	Print Color for Text Line #6	same as measurement channel #1
000CH	Byte	Print Color for Text Line #7	same as measurement channel #1
000DH	Byte	Print Color for Text Line #8	same as measurement channel #1
000EH	Byte	Print Color for Text Line #9	same as measurement channel #1
000FH	Byte	Print Color for Text Line #10	same as measurement channel #1
0010H	Byte	Print Color for Measurement Value Table	same as measurement channel #1
0011H	Byte	Print Color for Date and Time	00H = none 01H = violet 02H = red 03H = black 04H = green 05H = blue 06H = brown 07H = change daily
0012H	Byte	Print Color for Time	same as print color for date and time

5.3.7 Assignment, DI 1BH

Parameter Address (offset)	Data Type	Function and Code	
0000H	Byte	Activate Event Mark #1	00H = off 01H = DO 1 . = . . = . 0EH = DO 14
0001H	Byte	Activate Event Mark #2	same as event mark #1
0002H	Byte	Activate Event Mark #3	same as event mark #1
0003H	Byte	Activate Event Mark #4	same as event mark #1
0004H	Byte	Initiate Print-Out Text Line #1	same as event mark #1
0005H	Byte	Initiate Print-Out Text Line #2	same as event mark #1
0006H	Byte	Initiate Print-Out Text Line #3	same as event mark #1
0007H	Byte	Initiate Print-Out Text Line #4	same as event mark #1
0008H	Byte	Initiate Print-Out Text Line #5	same as event mark #1
0009H	Byte	Initiate Print-Out Text Line #6	same as event mark #1
000AH	Byte	Initiate Print-Out Text Line #7	same as event mark #1
000BH	Byte	Initiate Print-Out Text Line #8	same as event mark #1
000CH	Byte	Initiate Print-Out Text Line #9	same as event mark #1

Parameter Address (offset)	Data Type	Function and Code	
000DH	Byte	Initiate Print-Out Text Line #10	same as event mark #1
000EH	Byte	Initiate Print-Out Measurement Value Table	same as event mark #1
000FH	Byte	Initiate Print-Out Date and Time	same as event mark #1
0010H	Byte	Enable Parameter Setting	same as event mark #1
0011H	Byte	External Selection Advance 1 to 2	same as event mark #1
0012H	Byte	Control Input for Synchronization Clock	same as event mark #1
0013H	Byte	Delete Print Queue	same as event mark #1
0014H	Byte	Activate Standby	same as event mark #1

5.3.8 Date and Time, 1CH

Parameter Address (offset)	Data Type	Function and Code	
0000H	Byte	Day	01H ... 1FH = 1 ... 31
0001H	Byte	Month	01H ... 0CH = 1 ... 12
0002H	Byte	Year	00H ... 63H = 00 ... 99
0003H	Byte	Hour	00H ... 17H = 00 ... 23
0004H	Byte	Minute	00H ... 3BH = 00 ... 59

5.3.9 Calibration Data, 1DH

[Data can only be read]

Parameter Address (offset)	Data Type	Function and Code	
0000H	Word	Lower Limit Value Channel 1:	0000 ... FFFF
0002H	Word	Upper Limit Value Channel 1:	0000 ... FFFF
0004H	Word	Lower Limit Value Channel 2:	0000 ... FFFF
0006H	Word	Upper Limit Value Channel 2:	0000 ... FFFF
0008H	Word	Lower Limit Value Channel 3:	0000 ... FFFF
000AH	Word	Upper Limit Value Channel 3:	0000 ... FFFF
000CH	Word	Lower Limit Value Channel 4:	0000 ... FFFF
000EH	Word	Upper Limit Value Channel 4:	0000 ... FFFF
0010H	Word	Lower Limit Value Channel 5:	0000 ... FFFF
0012H	Word	Upper Limit Value Channel 5:	0000 ... FFFF
0014H	Word	Lower Limit Value Channel 6:	0000 ... FFFF
0016H	Word	Upper Limit Value Channel 6:	0000 ... FFFF
0018H	Word	Zero Point Offset Print Head:	0 ... 100
001AH	Word	Total Number of Steps:	980 ... 1000
001CH	Word	Zero Point Offset Scale:	0 ... 100

5.3.10 Channel Measurement Values and Device Status, 1EH

[Data can only be read]

Parameter Address (offset)	Data Type	Function and Code	
0000H	Float	Measurement Channel 1	
0004H	Float	Measurement Channel 2	
0008H	Float	Measurement Channel 3	
000CH	Float	Measurement Channel 4	
0010H	Float	Measurement Channel 5	
0014H	Float	Measurement Channel 6	

Parameter Address (offset)	Data Type	Function and Code
0018H	Byte	DI Status, Binary Inputs at Recorder Bit 0 DI 1 1 DI 2 2 DI 3 3 DI 4 4 DI 5 5 DI 6 6 DI xx 7 DI xx
0019H	Byte	DI Status, Binary Inputs via I/O Converter Bit 0 DI 7 1 DI 8 2 DI 9 3 DI 10 4 DI 11 5 DI 12 6 DI 13 7 DI 14
001AH	Byte	DO Status, Binary Inputs at Recorder Bit 0 DO 1 1 DO 2 2 DO 3 3 DO 4 4 DO 5 5 DO 6 6 DO xx 7 DO xx
001BH	Word	DO Status, Binary Inputs via I/O Converter Bit 0 DO 7 1 DO 8 2 DO 9 3 DO 10 4 DO 11 5 DO 12 6 DO 13 7 DO 14 8 DO 15 9 DO 16 A DO 17 B DO 18 C DO 19 D DO 20
001DH	D-Word	Device Alarm Status BIT 00 01 CPU Error 02 Internal RAM Error 03 External RAM Error at CPU PC-Board 04 Communications Error Between CPU and Clock 05 Analog-Digital Converter Error 06 Check Sum Error, CPU PC-Board Parameter Data 07 Read Error at EEPROM on CPU PC-Board 08 Write Error at EEPROM on CPU PC-Board 09 Check Sum Error, Channel Adapter Calibration Data 0A Read Error at EEPROM on Channel Adapter 0B Write Error at EEPROM on Channel Adapter 0C Device Reset Generated by Watchdog 0D Print Queue Full 0E Print Head Jammed 0F Voltage to Clock Component Interrupted 10 Advance too Fast for Text Printing 11 Device Reset Generated by Oscillator Watchdog 12 Communications Error at I/O Converter 13 F-RAM Check Sum Error 14 Read Error at F-RAM 15 Write Error at F-RAM 16 Reference Point Correction Error

Parameter Address (offset)	Data Type	Function and Code
0021H	D-Word	Device Alarm; Acknowledgement Status same messages as device alarm status
0025H	D-Word	Limit Value; Alarm Status Bit 0 LV 1, Channel 1 1 LV 1, Channel 2 2 LV 1, Channel 3 3 LV 1, Channel 4 4 LV 1, Channel 5 5 LV 1, Channel 6 6 xx 7 xx 8 LV 2, Channel 1 9 LV 2, Channel 2 A LV 2, Channel 3 B LV 2, Channel 4 C LV 2, Channel 5 D LV 2, Channel 6
0029H	D-Word	Limit Value; Acknowledgement Status same messages as limit value status
002DH	Byte	Device Type 00H = direct-reading 01H = LCD display 02H = LED display
002EH	Byte	Limit Value 00H = none 01H = installed
002FH	Word	Remaining Paper Length 0000H ... 0C80H (0 ... 3200 cm)
0031H	Byte	Standby Status 00H = Recording Operation 01H = Standby
0032H	Byte	Status, Measurement Channel #1 Bit 0 = Overflow 1 = Underflow 2 = Reserved 3 = Reserved 4 = Line Interruption, Display 0 5 = Line Interruption, Display 100
0033H	Byte	Status, Measurement Channel #2 same as measurement channel #1
0034H	Byte	Status, Measurement Channel #3 same as measurement channel #1
0035H	Byte	Status, Measurement Channel #4 same as measurement channel #1
0036H	Byte	Status, Measurement Channel #5 same as measurement channel #1
0037H	Byte	Status, Measurement Channel #6 same as measurement channel #1
0038H	D-Word	Operating Hour Counter operating time in minutes (hex. coded)

5.3.11 Entering Measurement Values to the Recorder, 1FH

Entry of measurement values to the recorder is accomplished with a type SD2 message. The parameter field address 1FH is to be used as a base address. The measurement values are transmitted as normalized values. Allowable numbers range from 0 ... 1000.

Values outside of this range are not accepted by the recorder. If invalid measurement values occur, the message is answered with a negative acknowledgement. Data contained in the message are only processed by the recorder if the parameter "SER" is assigned to the corresponding channel. Received data are ignored with other measurement types.

The message format is as follows:

SD2/LE/LEr/SD2/DA/SA/FC/aa/oo/dd/cc/Data Array/FCS/ED

← L →

The following applies to this format:

SD2 = 68H	Start delimiter
LE	Number of data bytes + 7
LEr	LE read-back
SD2 = 68H	Start delimiter read-back
DA	Destination address (bus user address)
SA	Source address
FC	Function code (16H = write)
aa	Parameter field base address 1FH
bb	Offset high byte = 0
cc	Offset low byte
dd	Number of data bytes
ee	Data bytes
FCS	Check sum (sum of hex. values of the "L" frames without transmission at FFH)
ED = 16H	End delimiter
L	Number of bytes in FCS

Parameter Address (offset)	Data Type	Function and Code
0000H	Word	Meas. Value Channel #1 0000H ... 03E8H (0 ... 1000)
0002H	Word	Meas. Value Channel #2 0000H ... 03E8H (0 ... 1000)
0004H	Word	Meas. Value Channel #3 0000H ... 03E8H (0 ... 1000)
0006H	Word	Meas. Value Channel #4 0000H ... 03E8H (0 ... 1000)
0008H	Word	Meas. Value Channel #5 0000H ... 03E8H (0 ... 1000)
000AH	Word	Meas. Value Channel #6 0000H ... 03E8H (0 ... 1000)

5.3.12 Read Balancing Data, 20H

Balancing data are called up from base address 20H with an SD3 query. The data from a given measurement channel are transmitted in blocks as a message. Access to individual balancing function parameters is not provided for. The offset transmitted with the query determines the measurement channel number, whose data are to be read. The number of bytes must be entered into the query in correspondence with the size of the data array.

SD3/DA/SA/FC/aa/bb/bb/cc/xx/xx/xx/xx/FCS/ED

← L →

SD3 = A2H	Start delimiter
DA	Destination address (bus user address)
SA	Source address
FC = 15H	Function code
aa = 20H	Parameter field base address
bb bb	2 byte parameter address (offset)
cc = 27H	Number of data bytes
xx xx xx xx	Any 4 data bytes
FCS	Check sum (sum of the hex. values of the "L" frames)
ED = 6H	End delimiter
L	Number of bytes in FCS

Parameter Address (offset)	Data Type	Function
0000H	Block	Balancing Data to Measurement Channel #1
0001H	Block	Balancing Data to Measurement Channel #2
0002H	Block	Balancing Data to Measurement Channel #3
0003H	Block	Balancing Data to Measurement Channel #4
0004H	Block	Balancing Data to Measurement Channel #5
0005H	Block	Balancing Data to Measurement Channel #6

The recorder transmits a type SD 2 response message. The following definitions are included in this message:

Parameter Address (offset)	Data Type	Function
0000H	Byte	Balancing Interval
0001H	Float	Minimum
0005H	Float	Maximum
0009H	Float	Mean Value
000DH	Float	Balancing Sum
0011H	Byte	Interval Start Day
0012H	Byte	Interval Start Month
0013H	Byte	Interval Start Year
0014H	Byte	Interval Start Hour
0015H	Byte	Interval Start Minute
0016H to 001AH	Byte	Time and Date Minimum
001BH to 001FH	Byte	Time and Date Maximum
0020H to 0025H	Byte	Current Time and Current Date
0026H	Byte	Operating Mode for Balancing

5.3.13 Write Device Status, 21H

The length of the new paper roll is entered into this parameter field address after recording paper has been replaced.

The channel-specific double lines (scale and text lines) can be activated for immediate print-out.

Parameter Address (offset)	Data Type	Function and Code
0000H	Word	Paper Length (entry in cm) 0000H = do not change 0001H ... 0C80H (1 ... 3200)
0002H	D-Word	reserved
0006H	Byte	Save Parameter Assignment Immediately 00H = no 01H = yes
0007H	Byte	Print Double Lines Immediately 00H = none 01H = line 1 02H = line 2 03H = line 3 04H = line 4 05H = line 5 06H = line 6

6 Text Block Generation

If variable parameters are to be printed at the beginning or at the end of a batch process (assuming that the printer channel is installed in the recorder), a complete text line can be transmitted to the recorder with parameter field address F1H.

6.1 Transmit Print Lines to the Recorder

(with parameter field address F1H)

A text line with 32 characters is transmitted to the recorder with this message. The recorder enters the message into the print queue. Printing of the text begins as soon as the queue is empty, otherwise texts stored in the print queue are printed first. The recorder acknowledges the message with acknowledgement code 10H, if the message has been received error-free, and has been entered into the print queue. If there is no space available in the print queue, acknowledgement code 11H is transmitted in response.

The message format is as follows:

SD2/LE/LEr/SD2/DA/SA/FC/aa/bb/cc/dd/ee/ff/[Text Lines]/FCS/ED



The following applies to this format:

SD2 = 68H	Start delimiter
LE = 17H	Number of data bytes + 7
LEr = 17H	LE read-back
SD2 = 68H	Start delimiter read-back
DA	Destination address (bus user address)
SA	Source address
FC = 16H	Function code
aa = F1H	Parameter field base address
bb = 00H	Stuffing byte
cc = 00H	Stuffing byte
dd =	Length of text line + 2
ee =	Date control
	00H = print text without date or time
	01H = print text with time
	02H = print text with date
	03H = print text with date and time
ff =	Print color
	00h = none
	01H = violet
	02H = red
	03H = black
	04H = green
	05H = blue
	06H = brown
Text Line	Text line content max. 32 ASCII characters
FCS	Check sum
ED = 16H	End delimiter
L	Number of bytes in FCS

6.2 Printer Status Query

The number of lines in the print queue can be queried with the following message.

The query to the recorder is as follows:

SD3/DA/SA/FC/aa/oo/oo/cc/xx/xx/xx/xx/FCS/ED

L

The following applies to this format:

SD3 = A2H	Start delimiter
DA	Destination address (bus user address)
SA	Source address
FC = 15H	Function code
aa = F1H	Parameter field base address
oo oo = 0000H	2 byte parameter address (offset)
cc = 01H	Number of queried data bytes
xx xx xx xx	Any 4 bytes
FCS	Check sum (sum of the hex. values of the L frames)
ED = 16H	End delimiter
L	Number of bytes in FCS

The recorder responds as follows:

SD2/LE/LEr/SD2/DA/SA/FC/aa/FCS/ED

L

The following applies to this format:

SD2 = 68H	Start delimiter
LE = 17H	Number of data bytes + 7
LEr = 17H	LE read-back
SD2 = 68H	Start delimiter read-back
DA	Destination address (bus user address)
SA	Source address
FC = 15H	Function code
aa	Number of messages in queue
FCS	Check sum
ED = 16H	End delimiter
L	Number of bytes in FCS

6.3 Send Display Lines to Recorder, F2H (for display instruments)

A text line with a maximum of 16 characters is sent to the recorder with this message. The message appears in the display, if the control byte is set to a value of 01H.

The message format is as follows:

SD2/LE/LEr/SD2/DA/SA/FC/aa/bb/cc/dd/ee/[Text Line]/FCS/ED

L

The following applies to this format:

SD2 = 68H	Start delimiter
LE = 17H	Number of data bytes + 7
LEr = 17H	LE read-back
SD2 = 68H	Start delimiter read-back
DA	Destination address (bus user address)
SA	Source address
FC = 16H	Function code
aa = F2H	Parameter field base address
bb = 00H	Stuffing byte
cc = 00H	Stuffing byte
dd =	Length of text line + 1
ee =	Display control
	00H = do not display text
	01H = display text
Text Line	Text line content max. 16 ASCII characters
FCS	Check sum
ED = 16H	End delimiter
L	Number of bytes in FCS

6.4 Communications Error Registers, FFH

The communications error registers serve the purpose of error diagnosis for communications problems, which are caused by the transmission of invalid values.

Error registers are queried with the following message.

The query to the recorder is as follows:

SD3/DA/SA/FC/aa/oo/oo/cc/xx/xx/xx/xx/FCS/ED

L

The following applies to this format:

SD3 = A2H	Start delimiter
DA	Destination address (bus user address)
SA	Source address
FC = 15H	Function code
aa = FFH	Parameter field base address
oo oo = 0000H	2 byte parameter address (offset)
cc = 09H	Number of queried data bytes
xx xx xx xx	Any 4 bytes
FCS	Check sum (sum of the hex. values of the L frames)
ED = 16H	End delimiter
L	Number of bytes in FCS

The recorder responds as follows:

SD2/LE/LEr/SD2/DA/SA/FC/aa/bb/cc/dd/ee/FCS/ED

L

The following applies to this format:

SD2 = 68H	Start delimiter
LE = 17H	Number of data bytes + 7
LEr = 17H	LE read-back
SD2 = 68H	Start delimiter read-back
DA	Destination address (bus user address)
SA	Source address
FC = 15H	Function code
aa	Queried data array length
bb	Error type
	00H = no error
	01H = incorrect base field address
	02H = incorrect offset
	03H = incorrect value
	04H = incorrect length
	05H = header error
	06H = incorrect function code
cc	Field address at which error occurred
dd	Offset at which error occurred
ee	4 byte copy of incorrect value
FCS	Check sum
ED = 16H	End delimiter
L	Number of bytes in FCS

7 WIZCON Link at the Recorder

The following function codes and parameter addresses are provided for linking the recorder to WIZCON. The function codes used by the "vpidc.com" driver software are supported.

7.1 8 Value Query

(with SD3 message and function code 04H)

Used for the transmission of a query to the recorder.

The computer queries the recorder as follows:

```
SD3/DA/SA/FC/a1/a2/a3/a4/a5/a6/a7/a8/FCS/ED
      |-----L-----|
```

The following applies to this format:

SD3 = A2H Start delimiter
 DA Destination address (bus user address)
 SA Source address
 FC = 04H Function code
 a1 ... a8 Parameter addresses from chapter 7.4
 FCS Check sum (sum of the hex. values of the L frames)
 ED = 16H End delimiter
 L Number of bytes in FCS

Allowable addresses for a1...a8 are listed in chapter 7.4 "Parameter Addresses". If the same value is entered for two directly subsequent address fields, data from the repeated address, as well as all following addresses, are omitted.

The recorder responds as follows:

```
SD2/LE/LEr/SD2/DA/SA/04H/value1/value2/ ... /value8/FCS/ED
```

The maximum 8 values correspond to the addresses entered into the query. Each value is represented with 16 bits. The values are transmitted in the high byte - low byte sequence.

7.2 Changing 2 Values

(with SD3 message and function code 07H)

The query from the computer is as follows:

```
SD3/DA/SA/FC/c1/a1/val1/c2/a2/val2/FCS/ED
      |-----L-----|
```

The following applies to this format:

SD3 = A2H Start delimiter
 DA Destination address (bus user address)
 SA Source address
 FC = 07H Function code
 c1 = 01H Causes change at device
 a1 Parameter addresses from chapter 7.4
 val1 Parameter value
 c2 = 01H Causes change at device
 a2 Parameter addresses from chapter 7.4
 val2 Parameter value
 FCS Check sum (sum of the hex. values of the L frames)
 ED = 16H End delimiter
 L Number of bytes in FCS

c1 or c2 is the code which determines if the value is actually changed. If the code is 01H or 02H, the new value is stored by the recorder. Other values for c1 or c2 do not trigger any effect. The parameters a1/a2 are the corresponding parameter addresses. The new values (16 bit) are entered into the message at val1/val2.

The transmission sequence is high byte - low byte.

The recorder responds as follows:

```
SD1/DA/SA/qq/FCS/ED
```

qq is the acknowledgement code from the recorder. Where qq = 10H, the message has been processed error-free. In the event of an error, acknowledgement code 11H is transmitted. If only one value in the recorder is to be changed, the entry for val1 is to be repeated for val2 (WIZCON only allows a change to one value).

7.3 Numbers Format

Analog values are transmitted in a normalized format. Lower scale limit = 0 ‰ and upper scale limit = 1000 ‰ is used as a reference. Thus all possible values lie within a range of 0 to 1000.

Negative values cannot occur. The hexadecimal value assigned to a value per thousand is calculated as follows:

hex. value = value per thousand * 16 + 32768

Example: assuming the measurement value of one channel is 87 °C (= val) within a measurement range of -50 °C (= low) to + 150 °C (= high).

The corresponding hex. value results as follows:

hex. value = (val-low) / (high-low) * 1000 * 16 + 32768

= 0.685 * 16000 + 32768
 = 43728
 = **AAD0H**

Example:

Advance 1 = 120mm/hr. --> Index = 08H (from chapter 5.3.1).

The transmitted value is calculated as:

value = index * 16 + 32768 = 8080H.

7.4 Parameter Addresses for Function Codes 04H and 07H

Parameter Address	Content
00H	Measurement Value, Channel 1 (normalized)
01H	Measurement Value, Channel 2 (normalized)
02H	Measurement Value, Channel 3 (normalized)
03H	Measurement Value, Channel 4 (normalized)
04H	Measurement Value, Channel 5 (normalized)
05H	Measurement Value, Channel 6 (normalized)
06H	Advance Index 1
07H	Advance Index 2
08H	Internal Recorder Clock-Date
09H	Month
0AH	Year
0BH	Hour
0CH	Minute
	Limit Values for Channel 1
10H	Limit Value #1 (normalized)
11H	Limit Value #2 (normalized)
12H	Limit Value Function #1 (0 = min., 1 = max.)
13H	Limit Value Function #2 (0 = min., 1 = max.)
14H	Relay Output for Limit Value #1 (0 ... 20)
15H	Relay Output for Limit Value #2 (0 ... 20)
	Limit Values for Channel 2
18H	Limit Value #1 (normalized)
19H	Limit Value #2 (normalized)
1AH	Limit Value Function #1 (0 = min., 1 = max.)
1BH	Limit Value Function #2 (0 = min., 1 = max.)
1CH	Relay Output for Limit Value #1 (0 ... 20)
1DH	Relay Output for Limit Value #2 (0 ... 20)

Parameter Address	Content
	Limit Values for Channel 3
20H	Limit Value #1 (normalized)
21H	Limit Value #2 (normalized)
22H	Limit Value Function #1 (0 = min., 1 = max.)
23H	Limit Value Function #2 (0 = min., 1 = max.)
24H	Relay Output for Limit Value #1 (0 ... 20)
25H	Relay Output for Limit Value #2 (0 ... 20)
	Limit Values for Channel 4
28H	Limit Value #1 (normalized)
29H	Limit Value #2 (normalized)
2AH	Limit Value Function #1 (0 = min., 1 = max.)
2BH	Limit Value Function #2 (0 = min., 1 = max.)
2CH	Relay Output for Limit Value #1 (0 ... 20)
2DH	Relay Output for Limit Value #2 (0 ... 20)
	Limit Values for Channel 5
30H	Limit Value #1 (normalized)
31H	Limit Value #2 (normalized)
32H	Limit Value Function #1 (0 = min., 1 = max.)
33H	Limit Value Function #2 (0 = min., 1 = max.)
34H	Relay Output for Limit Value #1 (0 ... 20)
35H	Relay Output for Limit Value #2 (0 ... 20)
	Limit Values for Channel 6
38H	Limit Value #1 (normalized)
39H	Limit Value #2 (normalized)
3AH	Limit Value Function #1 (0 = min., 1 = max.)
3BH	Limit Value Function #2 (0 = min., 1 = max.)
3CH	Relay Output for Limit Value #1 (0 ... 20)
3DH	Relay Output for Limit Value #2 (0 ... 20)

7.5 Binary Information Queries

(with SD3 message and function code 05H)

Used for transmitting a query to the recorder. Values transmitted with function code 05 are not converted in accordance with the number format for analog values, because here only binary information is involved. The recorder uses one byte in the response message for each queried parameter address. The recorder sets unused bits to 0.

The computer queries the recorder as follows:

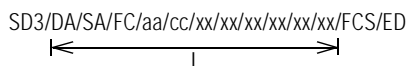

The following applies to this format:

- SD3 = A2H Start delimiter
- DA Destination address (bus user address)
- SA Source address
- FC = 05H Function code
- aa Start address = parameter address (chapter 7.6)
- cc Number of data bytes
- xx ... xx Any 6 bytes
- FCS Check sum (sum of the hex. values of the L frames)
- ED = 16H End delimiter
- L Number of bytes in FCS

The recorder responds as follows:



7.6 Parameter Addresses for Function Code 05H

Parameter Address	Content
00H	Limit Value Status, Channels 1 to 4
01H	Limit Value Status, Channels 5 and 6
02H	Status DI
03H	Status DO
04H	Device Self-Test Status, Bits 0 ... 7
05H	Device Self-Test Status, Bits 8 ... 15
06H	Device Self-Test Status, Bits 16 ... 23
07H	Device Self-Test Status, Bits 23 ... 31
08H	Parameter Assignment Status (01 = Recorder is in parameter setting mode, changes to parameter settings via the interface is not possible.)

Additional Explanations:

The limit value status of channels 1 to 4 is stored in one byte.

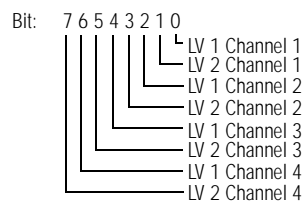

One additional byte is used to store the limit value status of channels 5 and 6.

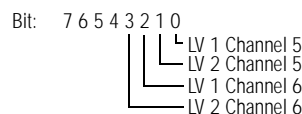

The status of binary inputs is stored in the lower 6 bits of one byte.

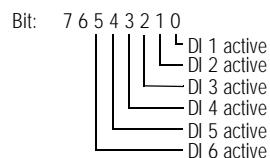

The status of binary outputs is stored in the lower 6 bits of one byte.

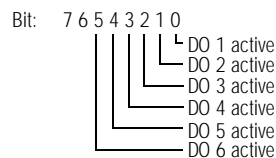

8 Character Table

Character	Code		Character	Code	
	Dec	Hex		Dec	Hex
2	01	01	:	58	3A
3	02	02	;	59	3B
‰	03	03	<	60	3C
↑	04	04	=	61	3D
↓	05	05	>	62	3E
▲	06	06	?	63	3F
10	07	07	@	64	40
			A	65	41
	32	20	B	66	42
!	33	21	C	67	43
"	34	22	D	68	44
#	35	23	E	69	45
\$	36	24	F	70	46
%	37	25	G	71	47
&	38	26	H	72	48
'	39	27	I	73	49
(40	28	J	74	4A
)	41	29	K	75	4B
*	42	2A	L	76	4C
+	43	2B	M	77	4D
,	44	2C	N	78	4E
-	45	2D	O	79	4F
.	46	2E	P	80	50
/	47	2F	Q	81	51
0	48	30	R	82	52
1	49	31	S	83	53
2	50	32	T	84	54
3	51	33	U	85	55
4	52	34	V	86	56
5	53	35	W	87	57
6	54	36	X	88	58
7	55	37	Y	89	59
8	56	38	Z	90	5A
9	57	39	[91	5B

Character	Code		Character	Code	
	Dec	Hex		Dec	Hex
\	92	5C		124	7C
]	93	5D	}	125	7D
^	94	5E	→	126	7E
_	95	5F	←	127	7F
'	96	60	~	222	DE
a	97	61	°	223	DF
b	98	62	α	224	E0
c	99	63	ä	225	E1
d	100	64	β	226	E2
e	101	65	ε	227	E3
f	102	66	μ	228	E4
g	103	67	σ	229	E5
h	104	68	ζ	230	E6
i	105	69	g mit Unterl.	231	E7
j	106	6A	\	232	E8
k	107	6B	-1	233	E9
l	108	6C	j	234	EA
m	109	6D	■	235	EB
n	110	6E	Φ	236	EC
o	111	6F	£	237	ED
p	112	70	ñ	238	EE
q	113	71	ö	239	EF
r	114	72	p	240	F0
s	115	73	q	241	F1
t	116	74	Θ	242	F2
u	117	75	∞	243	F3
v	118	76	Ω	244	F4
w	119	77	ü	245	F5
x	120	78	Σ	246	F6
y	121	79	π	247	F7
z	122	7A	x	248	F8
{	123	7B			

Printed in Germany • Subject to change without notice

GOSSEN-METRAWATT GMBH
D-90327 Nuremberg, Germany

Company address:
Thomas-Mann-Strasse 16-20
D-90471 Nuremberg, Germany
Telephone ++49-911-8602 0
Telefax ++49-911-8602 669

